

ah! Ultra Minimalist



ah!UM

introduction

panoramah!® Ultra-Minimalist is based on the revolutionary vacuum insulating glass. This technology allows for 12mm total thickness glass to achieve triple glazing performance and by reducing glass thickness the overall aluminium structure of the window diminishes proportionally, resulting in an extremely slim and minimal system. Also, by using vacuum insulating glass, the vertical sightlines are reduced to an astonishing 15mm, even less than the initial systems based on standard double insulating glass.

The system can achieve pane surfaces up to approximately 4m² and allows for the introduction of a wide range of accessories.

sliding system

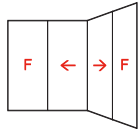
	fixed	sliding	pocket	corner
				
monorail	•		•	•
birail	•	•	•	•
multirail	•	•	•	•

main dimensions up to

vertical profile	15mm
max. leaf height	2500mm
max. leaf width	1800mm
max. weight	up to 600Kg/ glass pannel
max. glazed area	vacuum glazing up to 4,5m ²
glass thickness	12mm

performance up to

light transmission	up to 98%
thermal coefficient	Uw = 0.724W/m ² .K (Ug = 0.48W/m ² .K)
security	RC2 / WK2
sound insulation	37dB
water tightness	Class 5A
air tightness	Class 3
wind tightness	Class B3

Ultra-Minimalist



reddot award 2018
winner

- 1 main frame
- 2 polyamide
- 3 removable bearing profile
- 4 tempered vacuum insulated glass

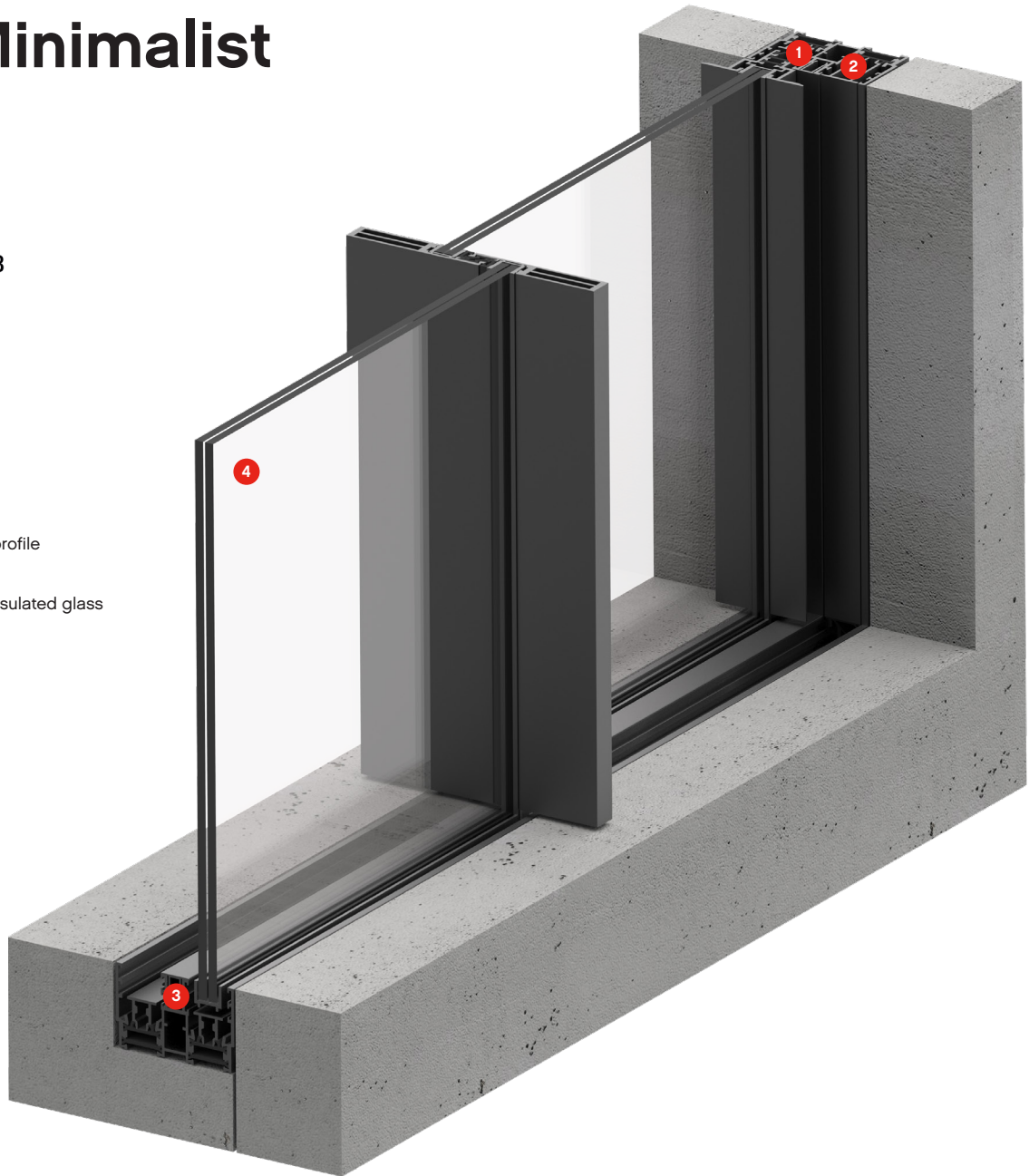

tempered vacuum insulated glass

- thin structure: glass, micro support pillars and metallic edge seal
- high energy saving: VIG $U_g=0,48W/m^2K$ vs IG $U_g=0,75m^2K$
- safety standards without laminating
- outstanding environmental adaptability: high thermal resistance
- surface compressive stress: $>90MPa$
- high noise reduction: against mid and low frequency noises
- less weight: VIG= $20Kg/m^2$ vs IG= $32Kg/m^2$
- estimated life: >25 years
- thermal insulation: 2-4 times than insulated glass

construction

finishes

All **panoramah!**® System series guarantee that the following finishes are carried out by duly certified entities, according to QUALICOAT and QUALANOD directives: Lacquered RAL, Lacquered PVDS, Anodized, Satin, Polished and Repellent.

motorisation

Our motorisation system can be adapted to all sliding or opening systems allowing a full integration with minimum interference in architectural design with a simplified and very quiet opening.



typologies

horizontal sliding system > monorail

fixed panel



double fixed panel

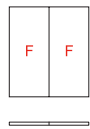

pocket

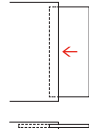

double pocket

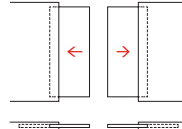

fixed corner

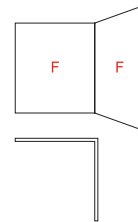

sliding corner + pocket

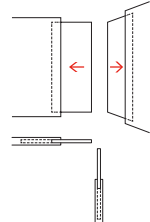

horizontal sliding system > birail

multiple fixed panels

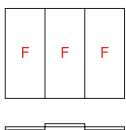

fixed + sliding

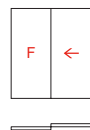

double sliding

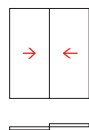

double pocket

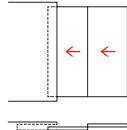

sliding + fixed + multiple sliding

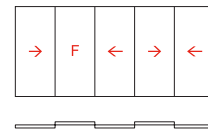

multiple sliding corner [out]

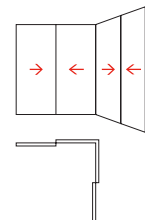

ah!UM

sliding birail common sections

1:3

scale

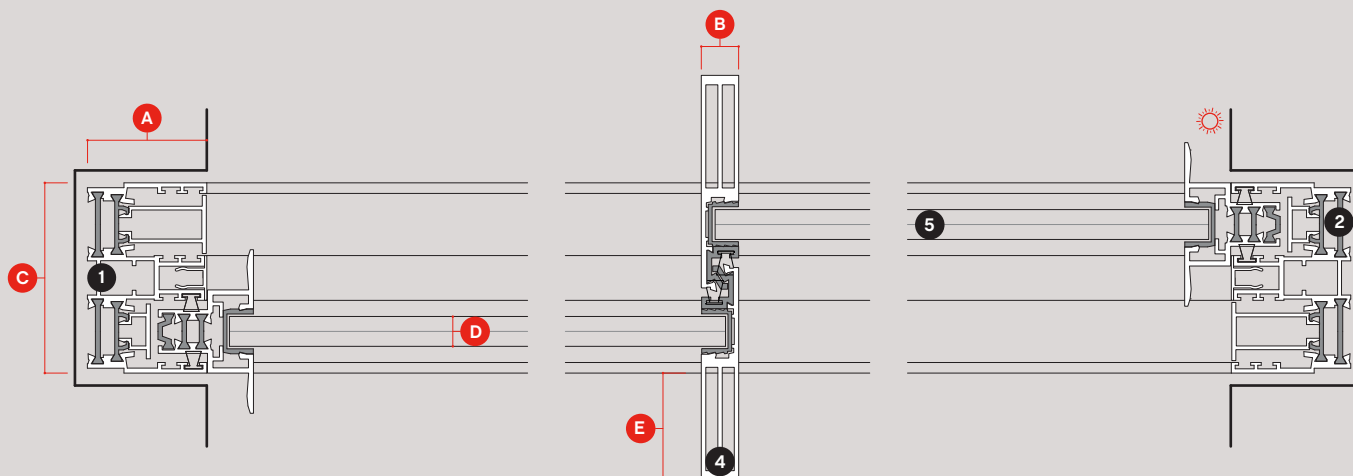

dimensions and main components

A 48mm	D 12mm
B 15mm	E 43mm
C 76mm	

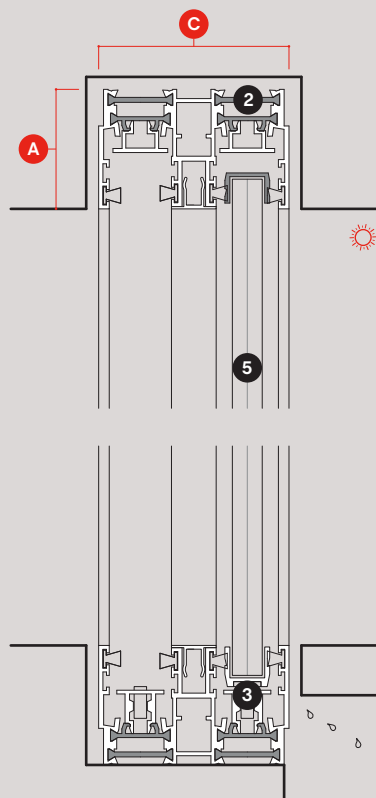

- 1** main frame
- 2** polyamide
- 3** removable bearing profile
- 4** central mullion
- 5** vacuum glass

we build **ah!**



unlimited perspective sa
ch philibert-de-sauvage 37
1219 chatelaine
switzerland

p. +41 21 804 1700
f. +41 21 804 1709

info@panoramah.com
www.panoramah.com

facebook
www.facebook.com/panoramah.ch/

instagram
www.instagram.com/_panoramah_/