

ah!60

ah!60

introduction

ah!60 is a groundbreaking exterior opening system with unmatched thermal and acoustic performance (up to Minergie-P and Passivhaus), ideal for very cold climates. It also stands out as an intrusion prevention solution for high demanding security specifications (RC4/WK4). It offers great flexibility in the modular composition of openings, including opening corner solutions, pocket sliding configurations, curved layouts, tilted spans and retractable mosquito nets. The alternatives come in a wide range of formats such as sliding and vertical sliding opening units. It allows for the introduction of a wide range of accessories, including heated glass, and it can be completely automated. ah!60 is a system that allows double glazed surface areas of up to 29m², or triple glazed of up to 19m². Both options use 20mm vertical profiles.

sliding system

	fixed	sliding	invisible	pocket	corner	curved	vertical
monorail	•			•	•	•	
birail	•	•	•	•	•	•	•
multirail	•	•	•	•	•	•	•

main dimensions up to

vertical profile	20mm	
max. leaf height	9000mm	
max. leaf width	9000mm	
max. weight	up to 2.000kg / glass pannel	
max. glazed area	double glazing	up to 29m ²
	triple glazing	up to 19m ²
glass thickness	60mm	

performance up to

light transmission	up to 98%
thermal coefficient	U _w = 0.708W/m ² .K (U _g = 0.41W/m ² .K)
security	RC4 / WK4
sound insulation	44dB
water tightness	Class E900
air tightness	Class 4
wind tightness	Class C5

- 1 main frame
- 2 polyamide
- 3 removable bearing profile
- 4 central mullion
- 5 glass

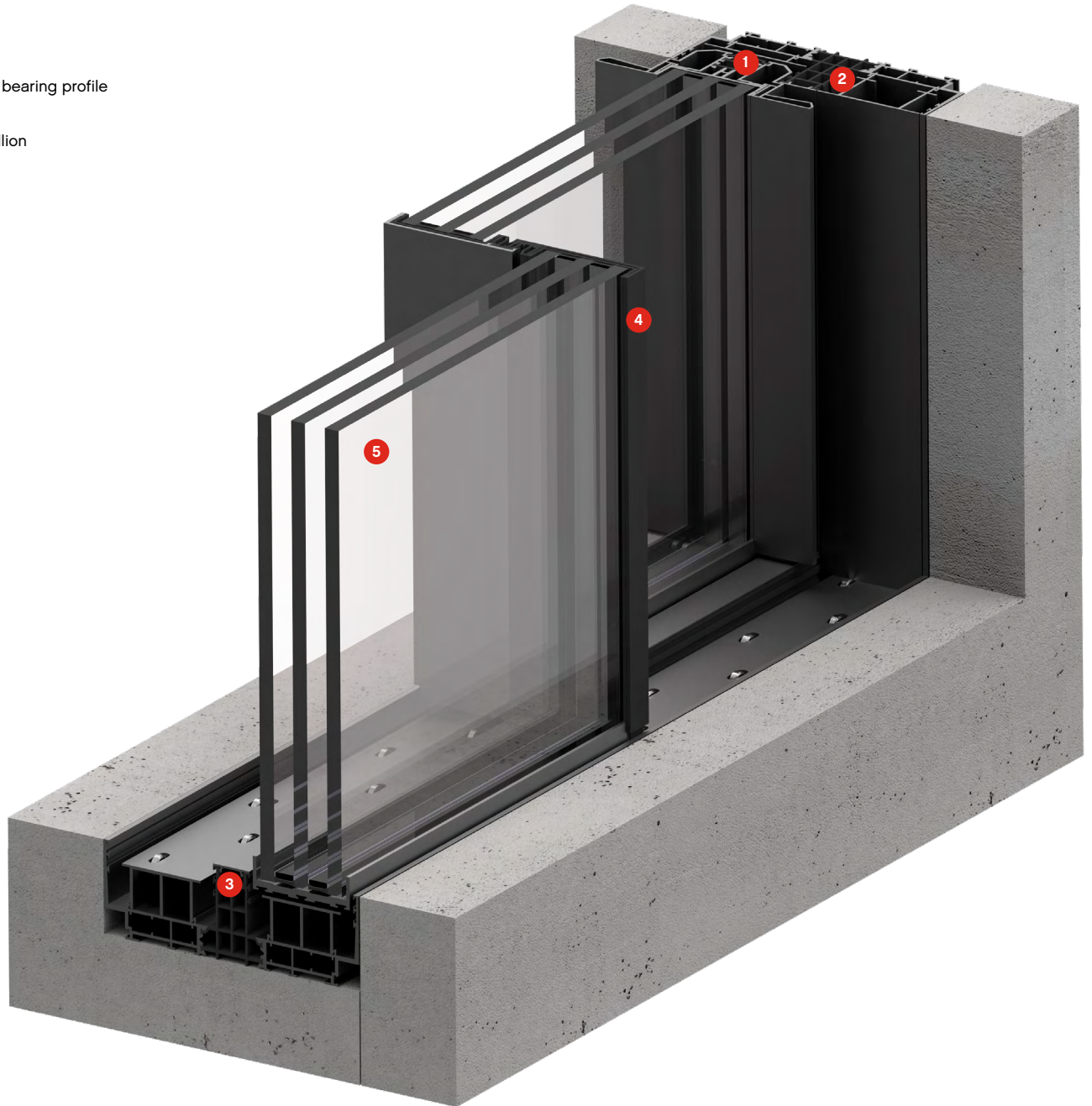

MINERGIE-P®
 Mehr Lebensqualität, tiefer Energieverbrauch
 Meilleure qualité de vie, faible consommation d'énergie

construction

finishes

All **panoramah!**® System series guarantee that the following finishes are carried out by duly certified entities, according to QUALICOAT and QUALANOD directives: Lacquered RAL, Lacquered PVDS, Anodized, Satin, Polished and Repellent.

add-ons

Insect screens / heated glass / intrusion detectors / balustrade / soft close

motorisation

Our motorisation system can be adapted to all sliding or opening systems allowing a full integration with minimum interference in architectural design with a simplified and very quiet opening.

typologies

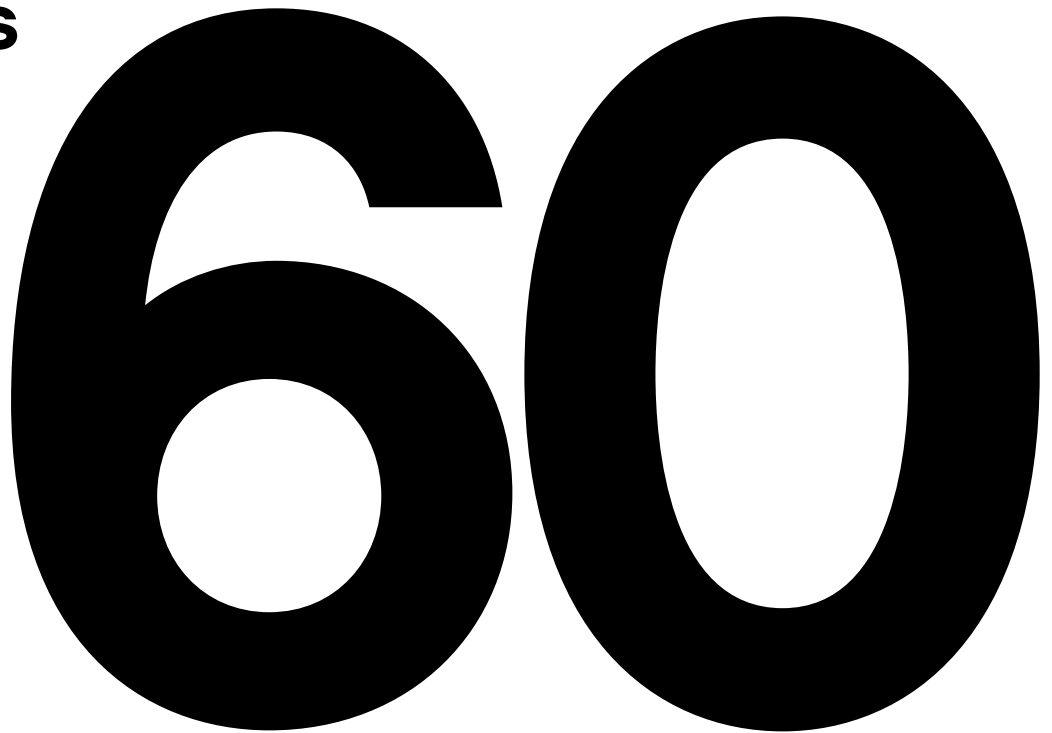

horizontal sliding system > monorail

fixed panel

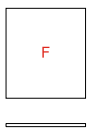

double fixed panel

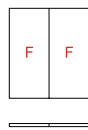

pocket

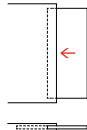

double pocket

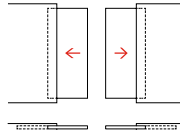

fixed corner

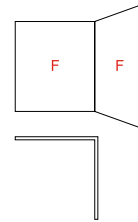

sliding corner + pocket

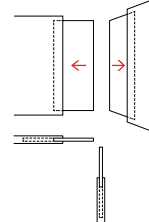

horizontal sliding system > birail

multiple fixed panels

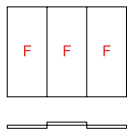

fixed + sliding



double sliding

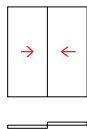

double pocket

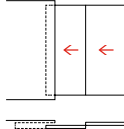

sliding + fixed + multiple sliding

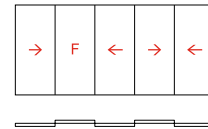

multiple sliding corner [out]

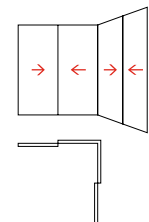

vertical sliding system > birail

double sliding

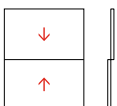

fixed + sliding + fixed

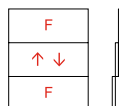

ah!60

sliding birail common sections

1:3

scale

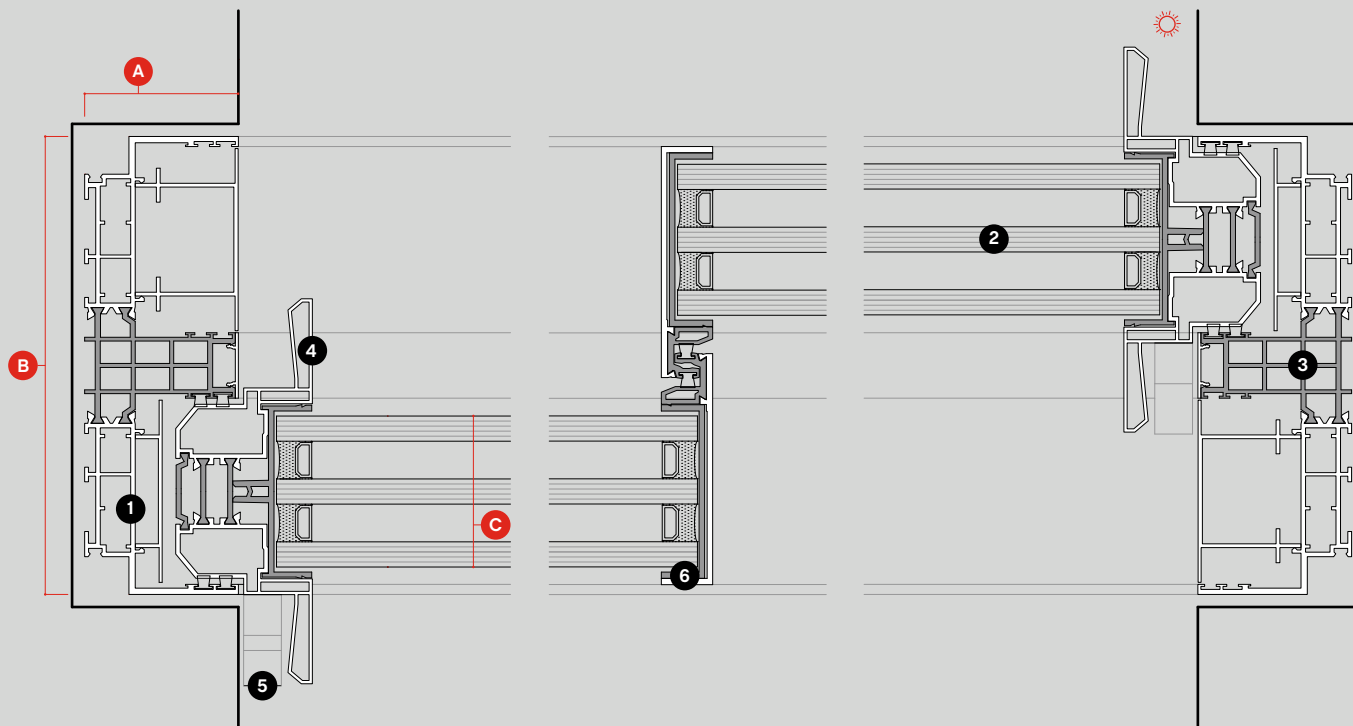

dimensions and main components

- A** 61mm
- B** 182mm
- C** 60mm

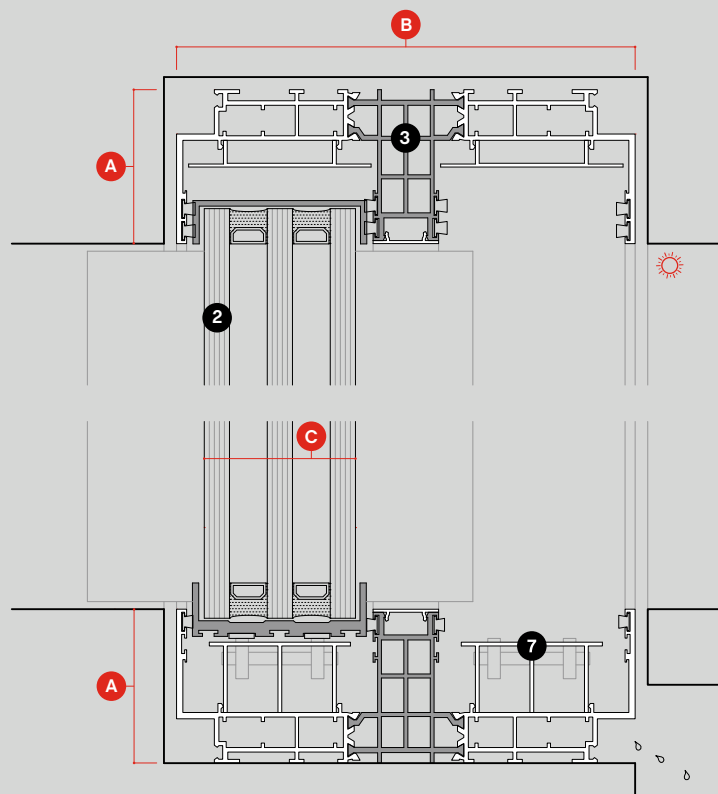

- 1** main frame
- 2** glass
- 3** polyamide
- 4** handle
- 5** multipoint locking system
- 6** central mullion
- 7** removable bearing profile

ah!60

invisible frame common sections

1:3

scale

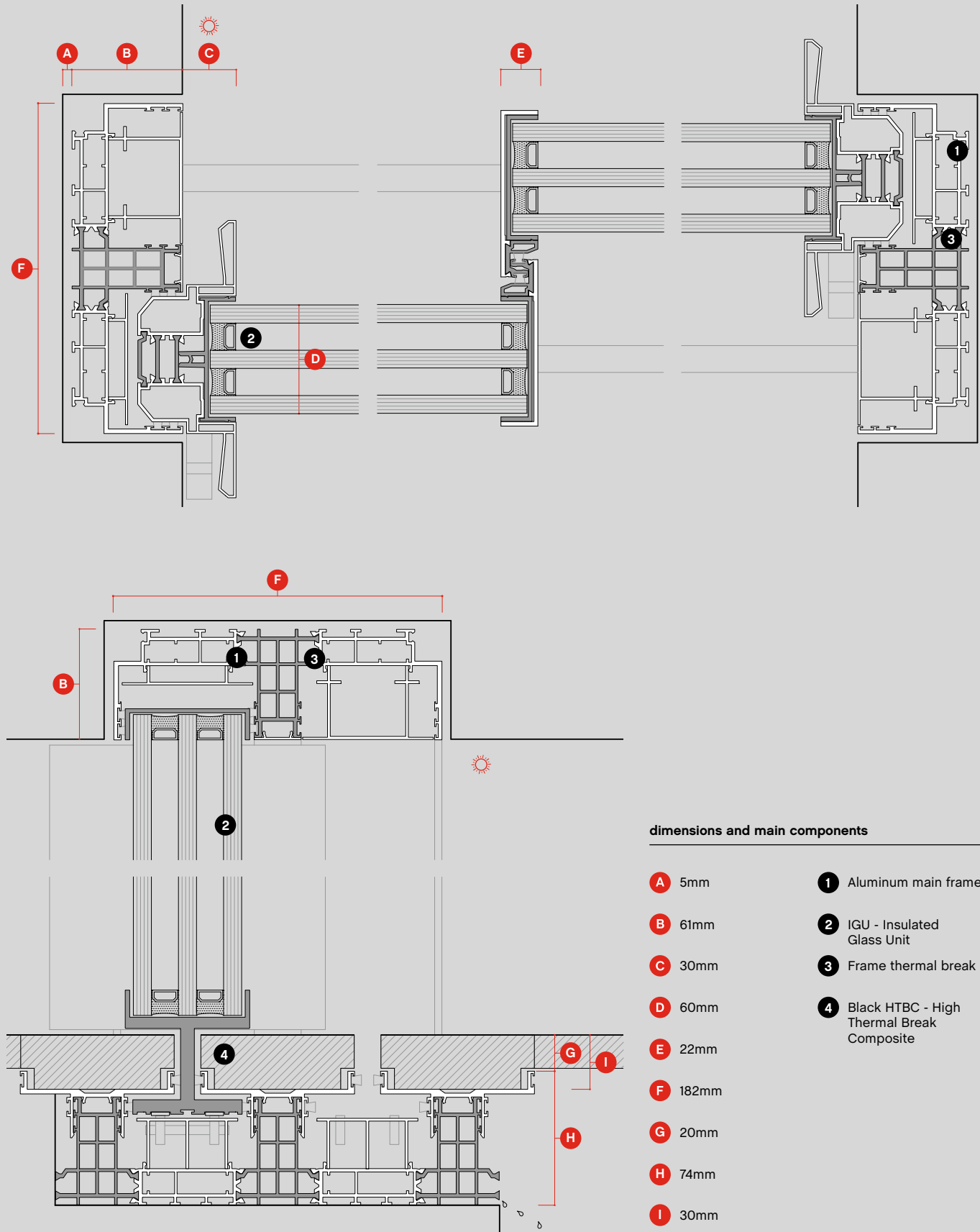

dimensions and main components

- | | |
|----------------|--|
| A 5mm | 1 Aluminum main frame |
| B 61mm | 2 IGU - Insulated Glass Unit |
| C 30mm | 3 Frame thermal break |
| D 60mm | 4 Black HTBC - High Thermal Break Composite |
| E 22mm | |
| F 182mm | |
| G 20mm | |
| H 74mm | |
| I 30mm | |

ah!60

pocket common sections

1:3

scale

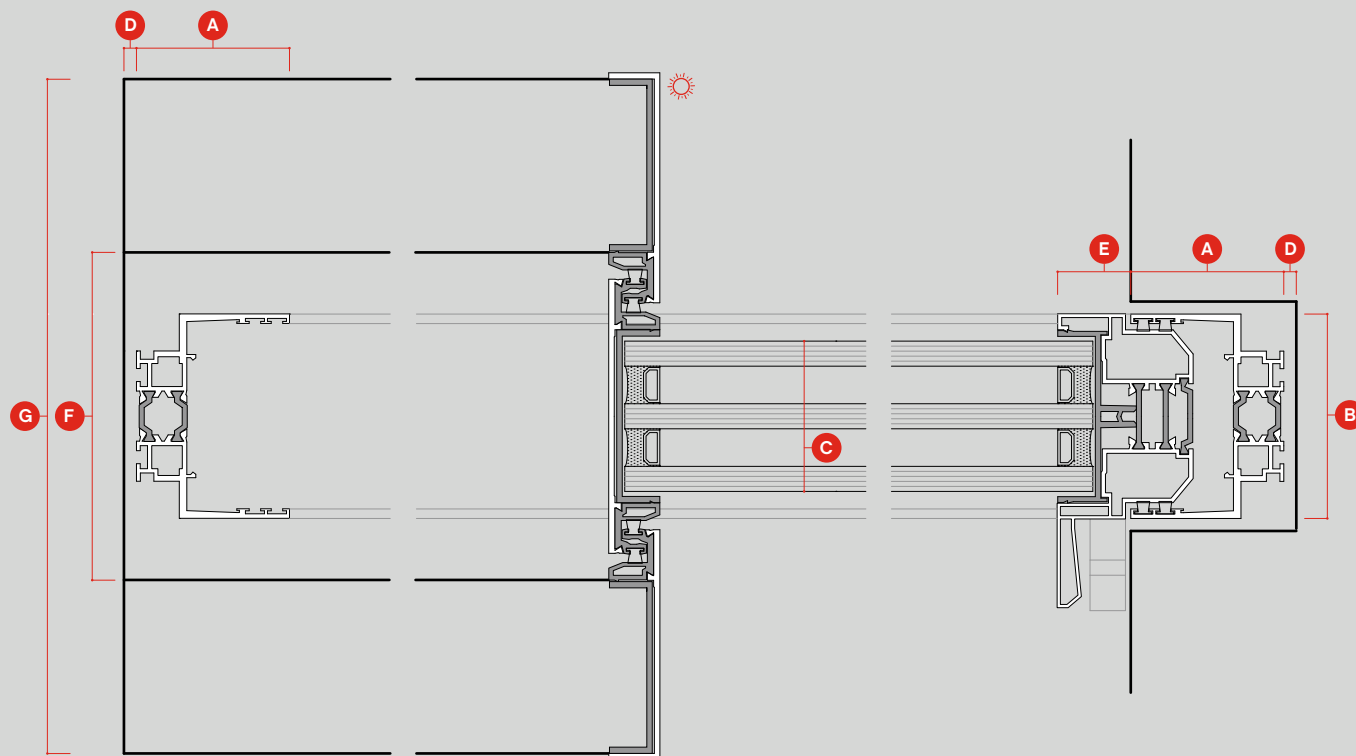

dimensions

A 61mm	E 29mm
B 82mm	F 136mm
C 60mm	G 269mm
D 5mm	

pocket

Opening configuration that allows for a complete recessing of the window's moving panels into a wall, ceiling or floor creating the experience of a full flowing space.

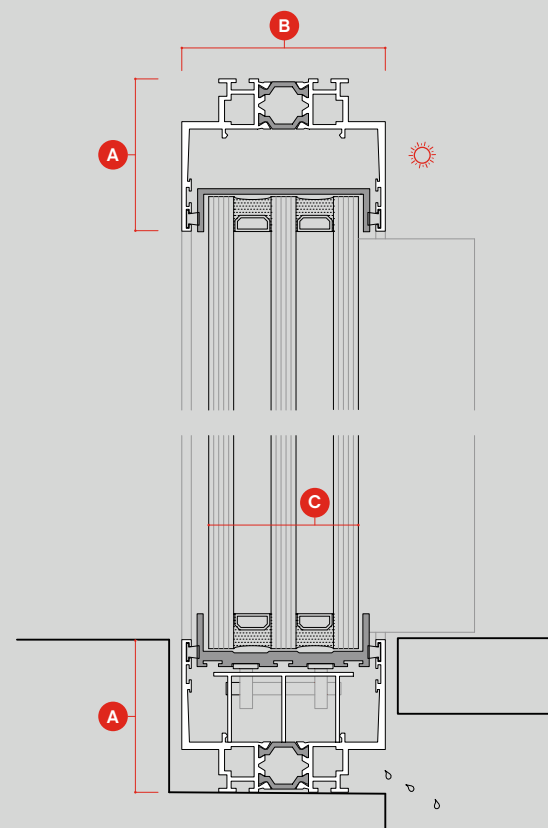

ah!60

vertical sliding common sections

1:3

scale

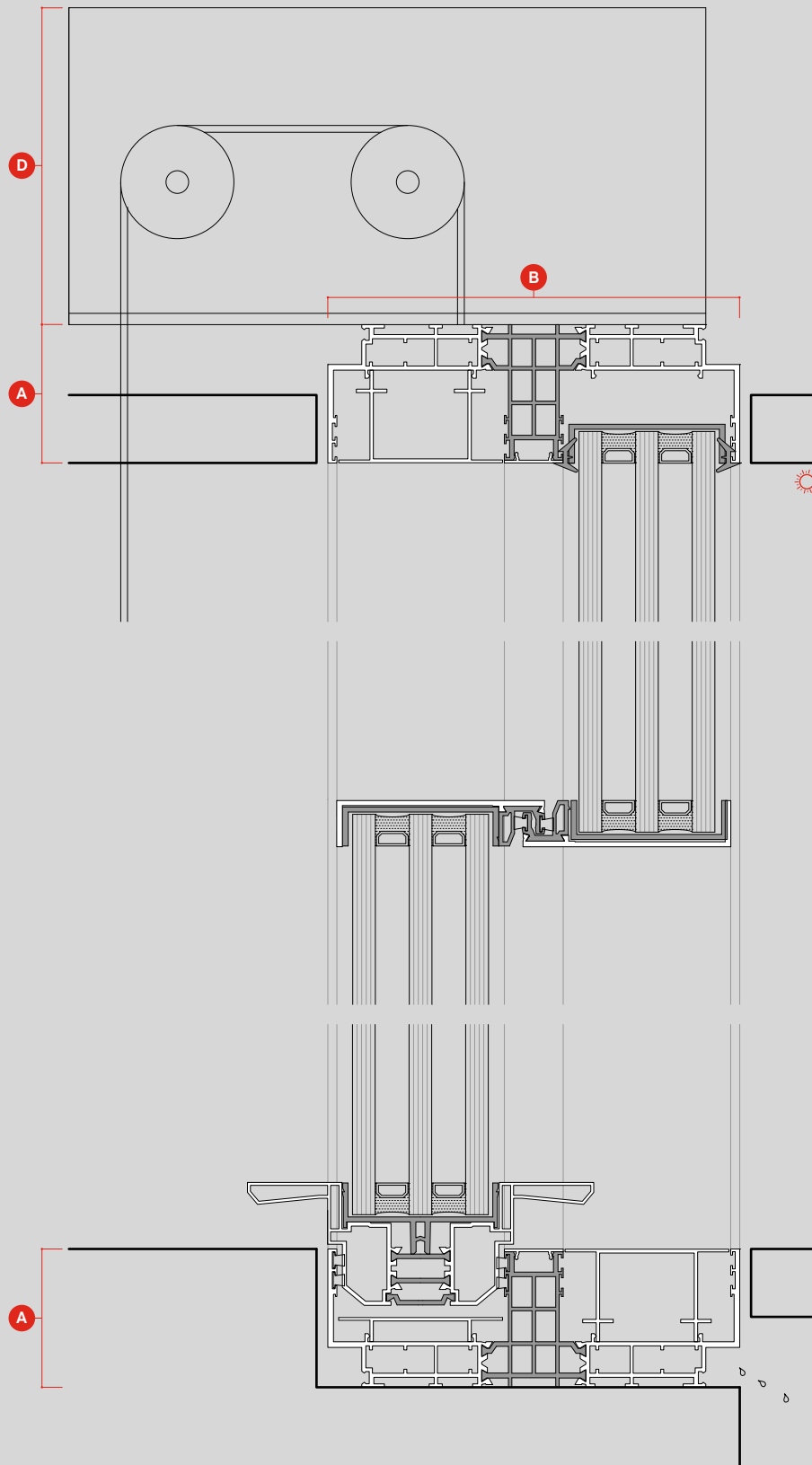

ah!60

vertical sliding common sections

1:3

scale

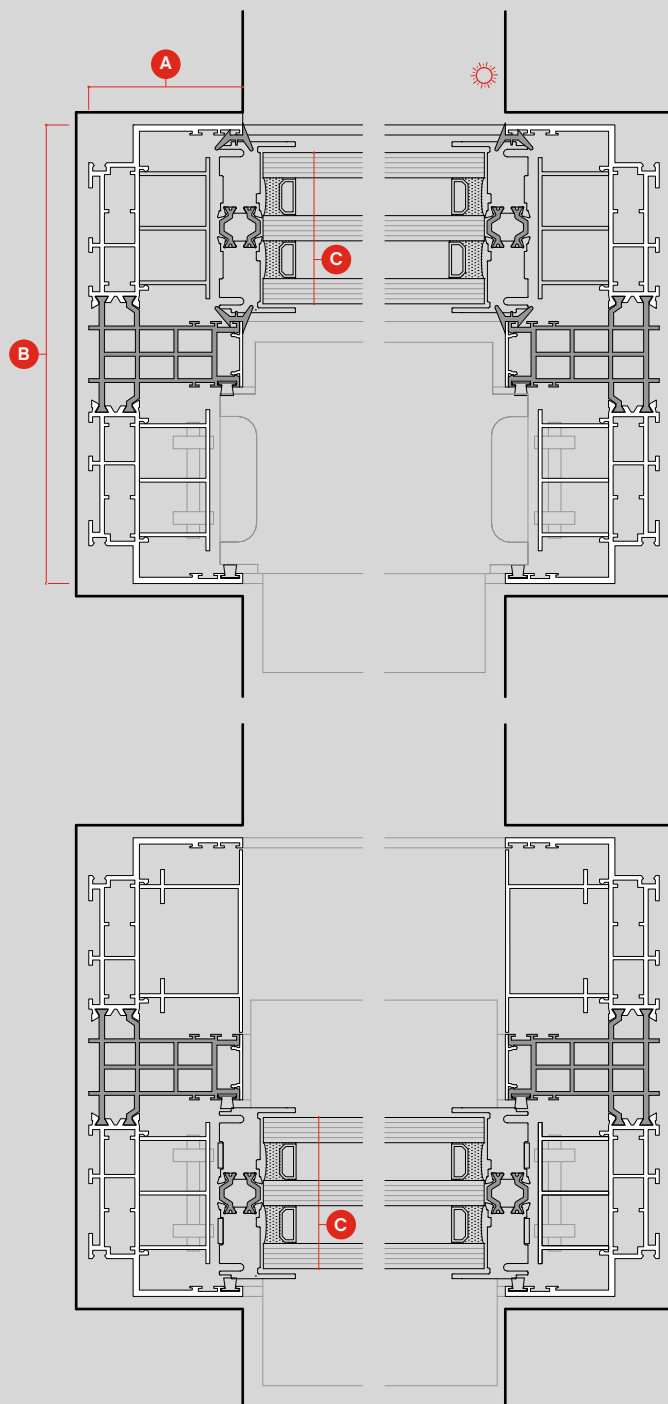

dimensions

A 61mm	C 60mm
B 182mm	D 150mm

vertical sliding guillotine

This opening system operates by connecting two or more vertical sliding glass panes through an internal counterweight system. Perfectly balanced the glass panes move effortlessly in opposite directions and are freed to cover large surface areas. This allows the use of horizontal aluminium profiles with reduced dimensions and a manual or motorised operation of very large units.

ah!60

pivot common sections, manual lock

1:3

scale

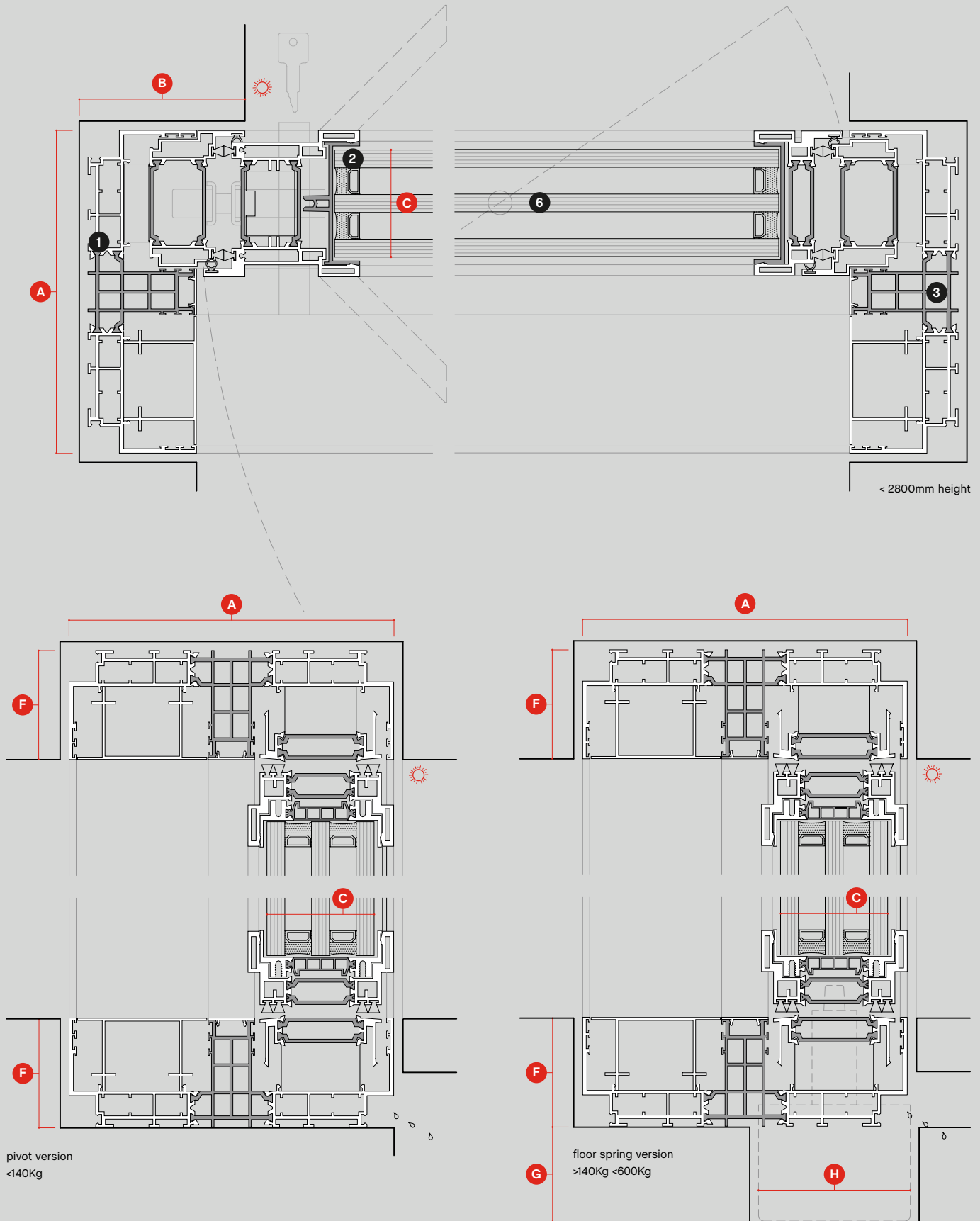

ah!60

pivot common sections, motorized lock

1:3

scale

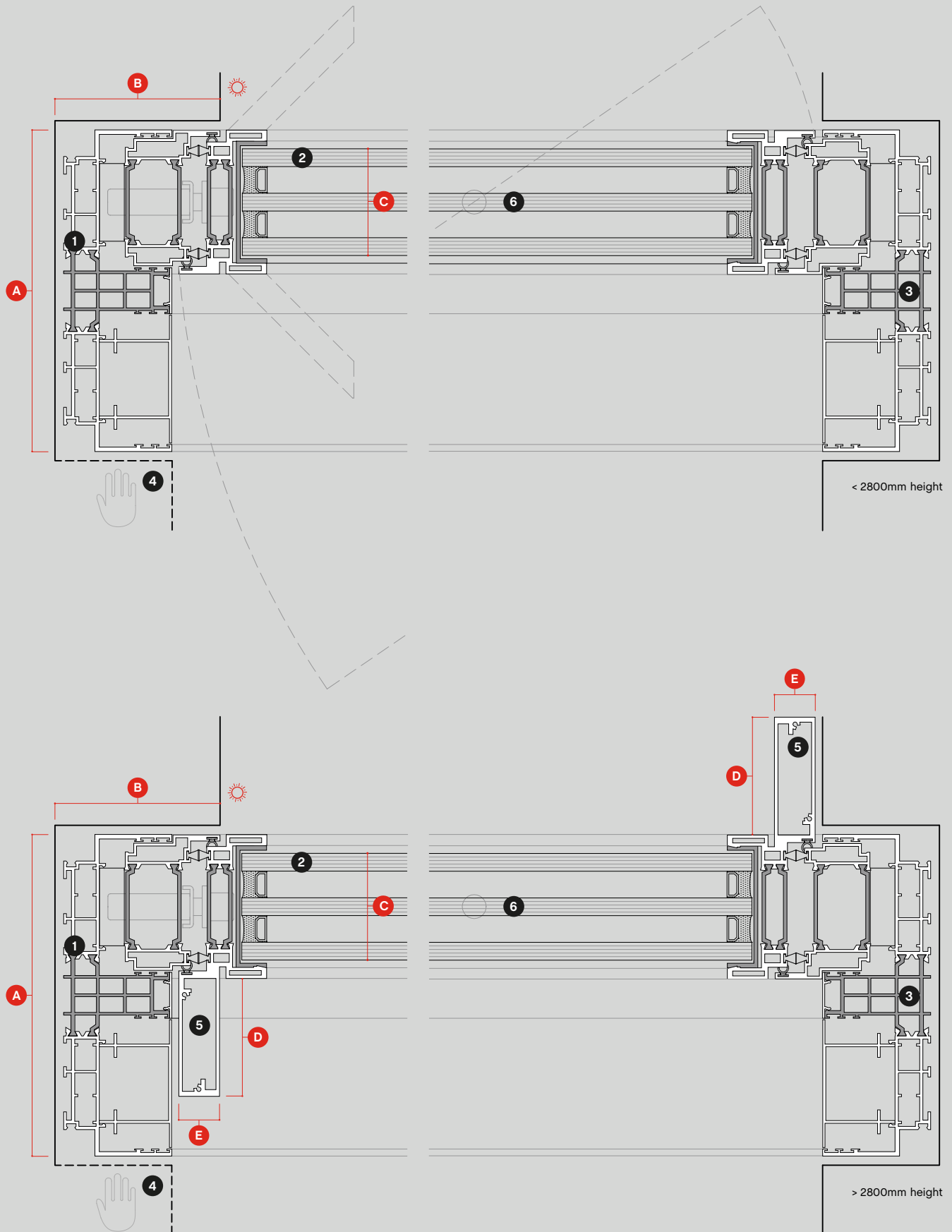

ah!60 Pivot

pivot common sections, motorized lock

1:3

scale

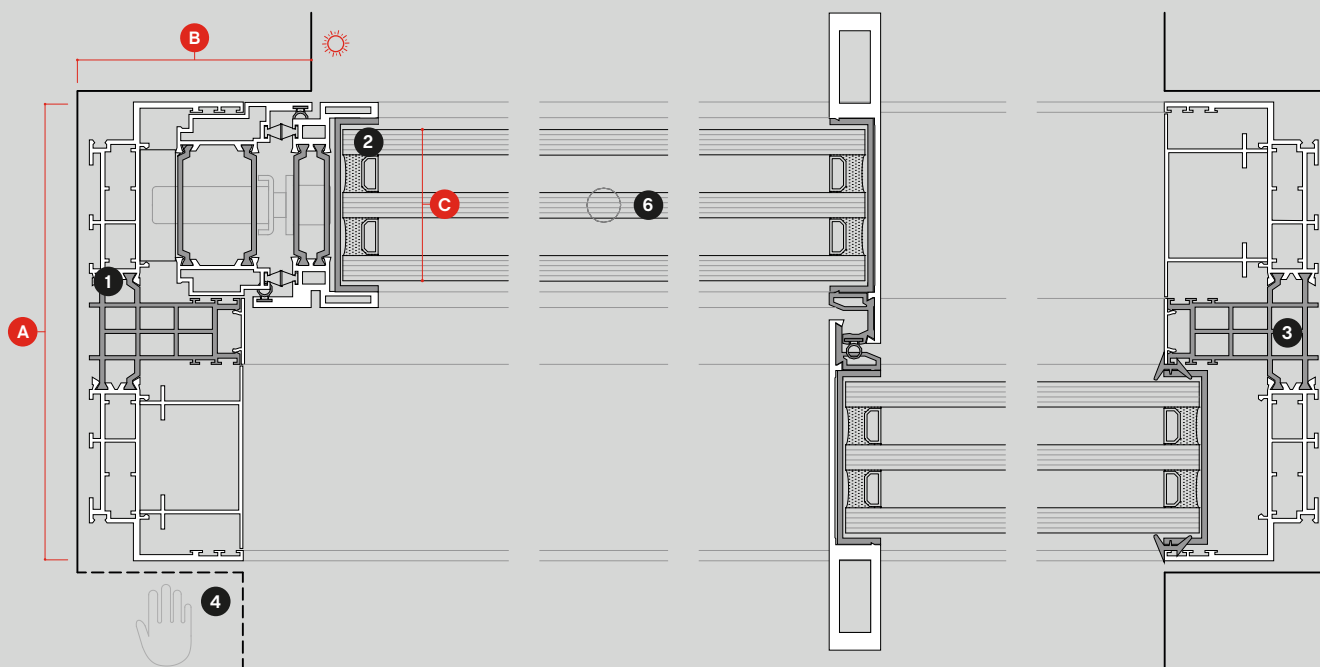

dimensions

- | | |
|----------------|--------------------------------|
| A 182mm | 1 main frame |
| B 88mm | 2 glass |
| C 60mm | 3 polyamide |
| D 67mm | 4 accessible area |
| E 23mm | 5 reinforced profile |
| F 61mm | 6 pivot or floor spring |
| G 53mm | |
| H 85mm | |

handle

finishes: stainless steel and lacquered steel

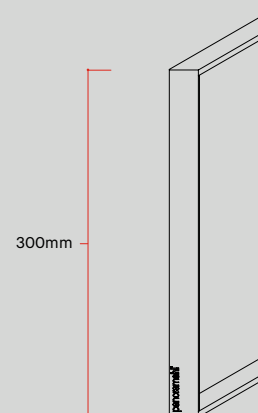

ah!60

corner common sections

1:3

scale

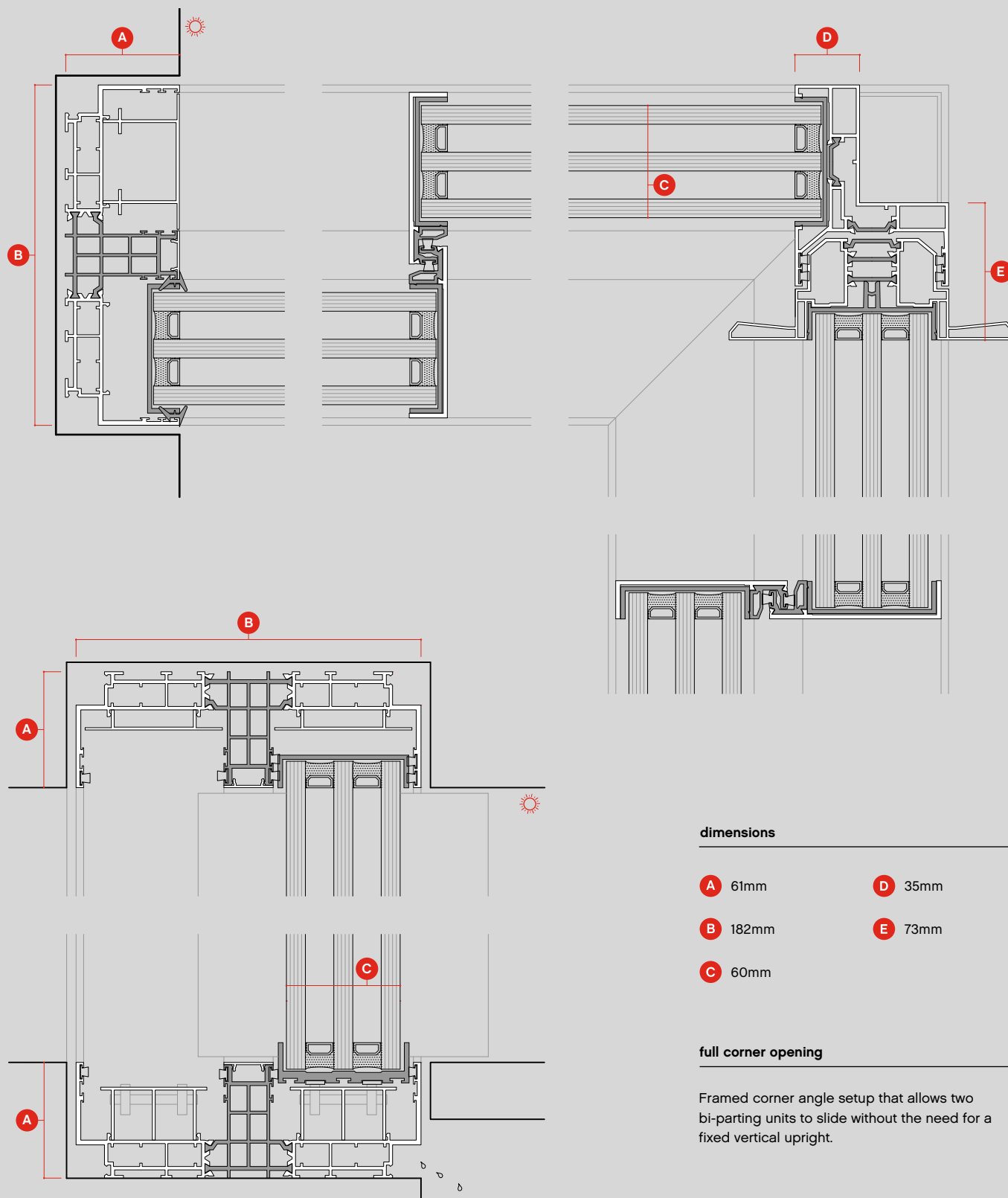

ah!60 motorisation

common sections

1:20

scale

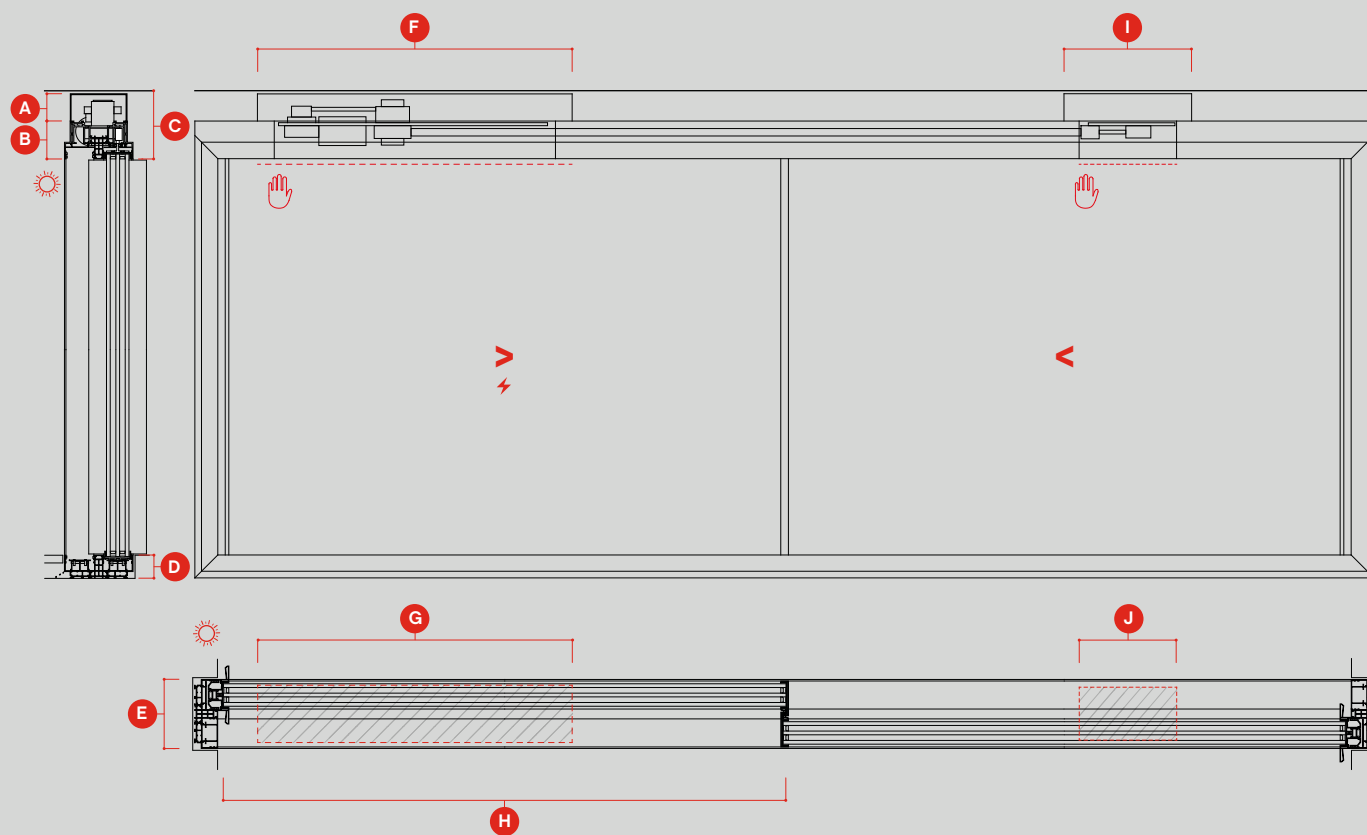

opening typologies

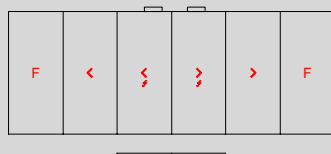
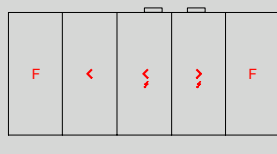
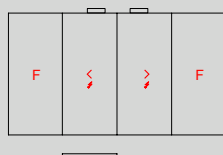
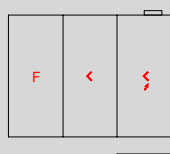

dimensions

A 75mm	F 840mm
B 100mm	G 750mm
C 180mm	H ≥1100mm
D 60mm	I 340mm
E 182mm	J 260mm



Gusto 501 | Toronto, Canada
Partisans
© Nic Lehoux



Villa S | Geneva, Switzerland
GM Architectes Associés
© Julia Wimmerlin





Villa D | Vaud, Switzerland
Grégory GARCIA Architecte DPLG
© Adrien Barakat



we build **ah!**



unlimited perspective sa
ch philibert-de-sauvage 37
1219 chatelaine
switzerland

p. +41 21 804 1700
f. +41 21 804 1709

info@panoramah.com
www.panoramah.com

facebook
www.facebook.com/panoramah.ch/

instagram
www.instagram.com/_panoramah_/